

# 10 Metal Puzzles - Blue



Objective of the Puzzle: Disassemble and reassemble.

Manufacturer: Eureka

Difficulty: Level 6-9 (out of 10)

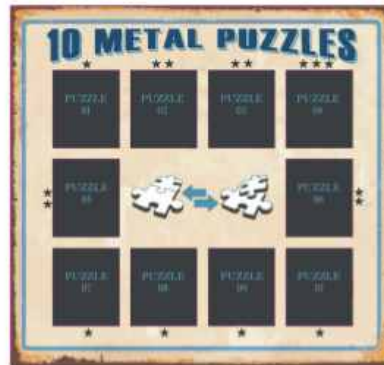

© Eureka bvba 2015  
2800 Mechelen, Belgium  
All rights reserved

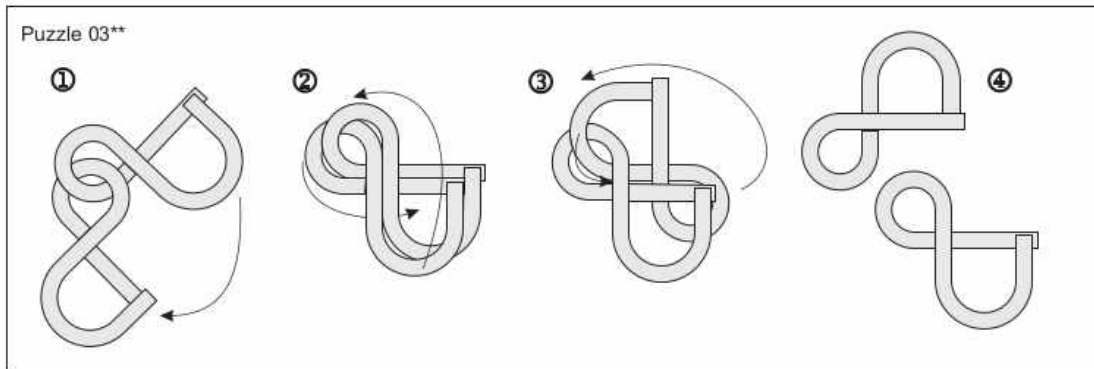
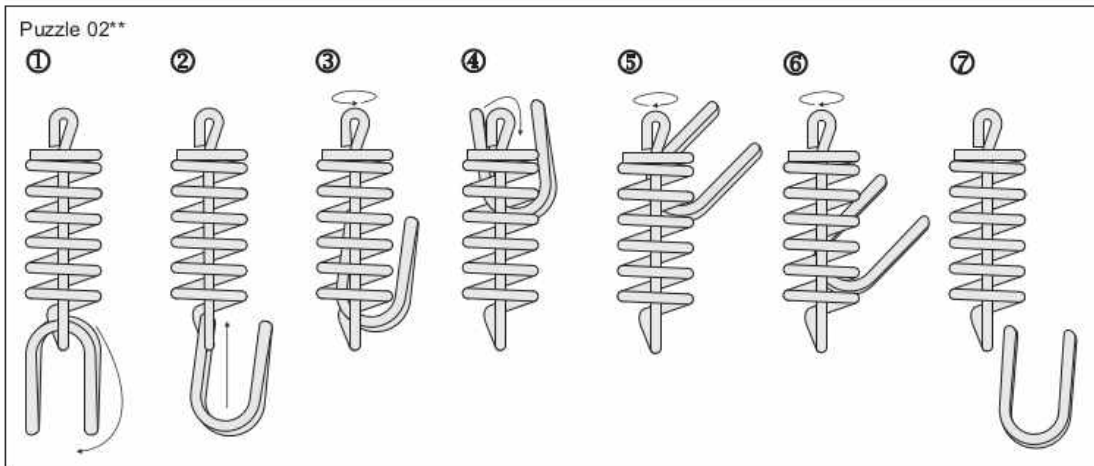
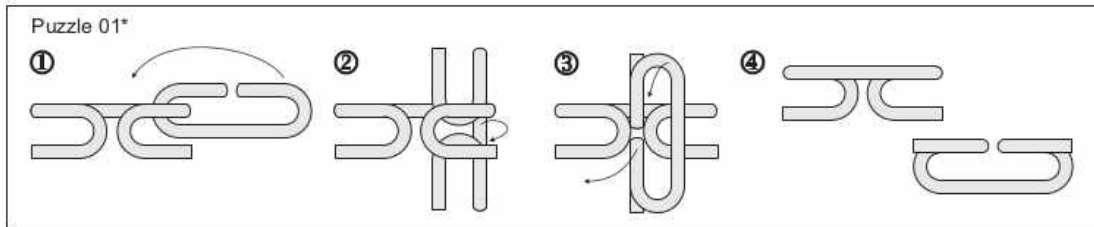

# 10 Metal Puzzles - Blue



Objective of the Puzzle: Disassemble and reassemble.

Manufacturer: Eruka

Difficulty: Level 6-9 (out of 10)

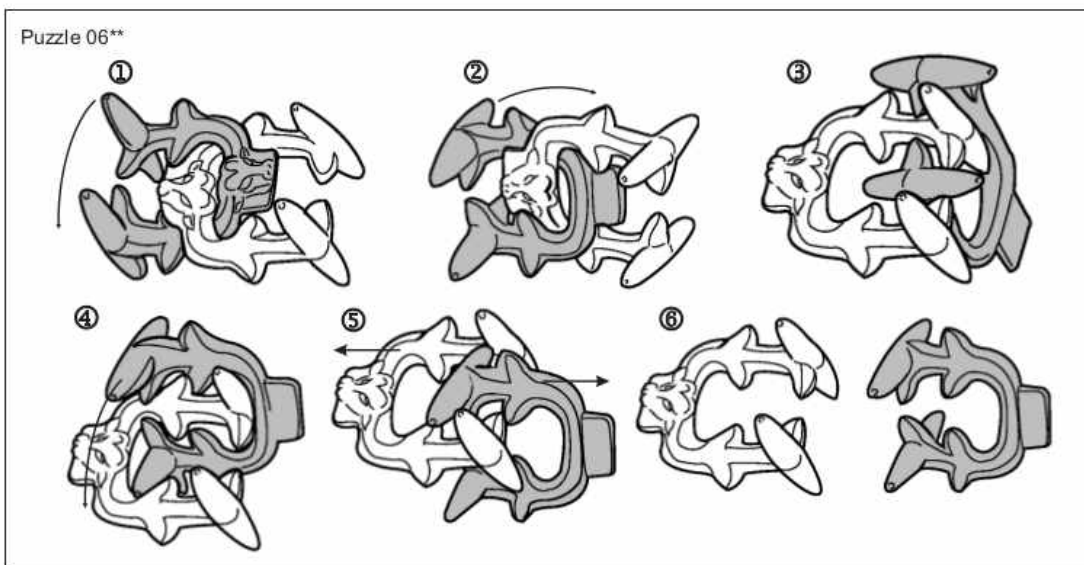
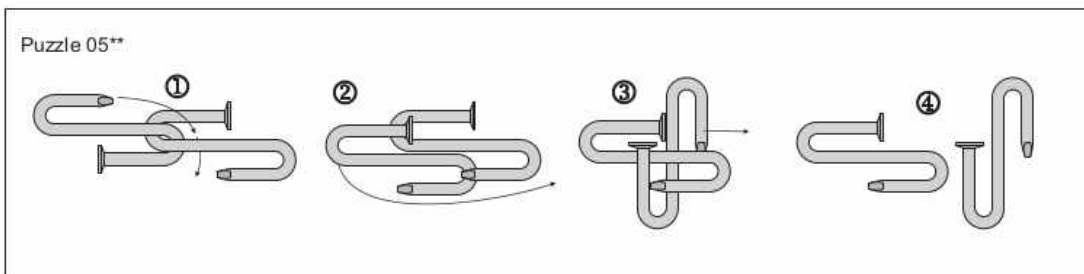
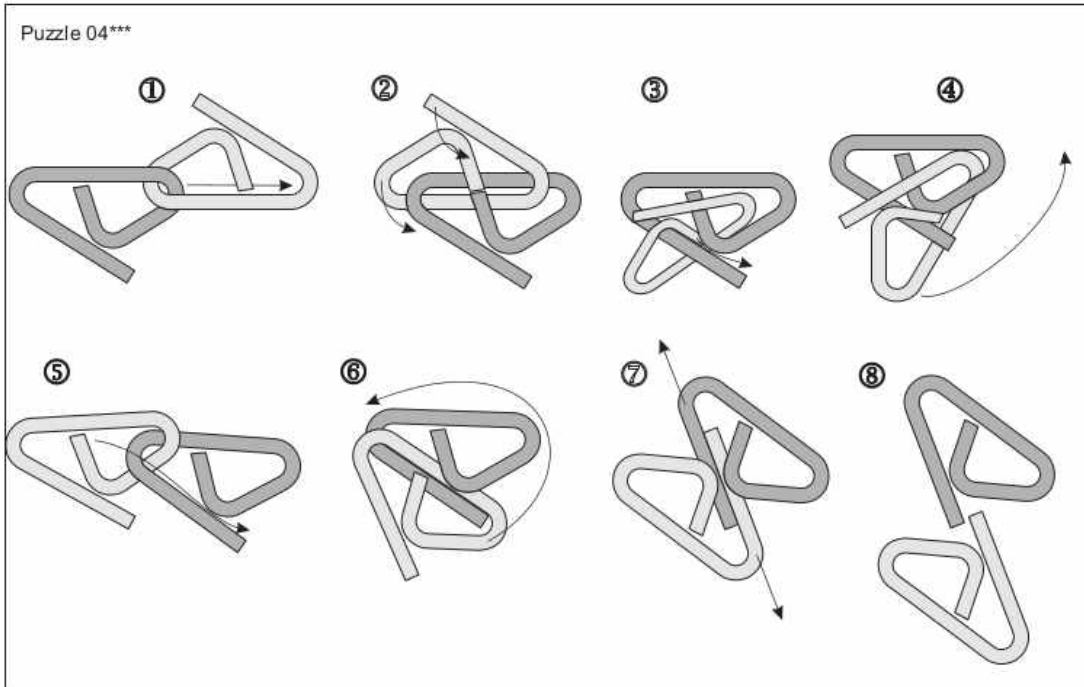

# 10 Metal Puzzles - Blue



Objective of the Puzzle: Disassemble and reassemble.

Manufacturer: Erueka

Difficulty: Level 6-9 (out of 10)

